

Component Mounting Side of PCB



Insert Arrangement

6-4, 8-4

4 #23 Contacts
.022 (0.56) Max. Dia. Tail

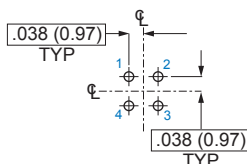

Pin Connector

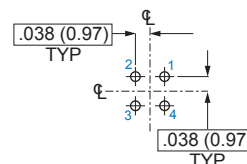

Socket Connector



Insert Arrangement

5-3

3 #23 Contacts
.022 (0.56) Max. Dia. Tail

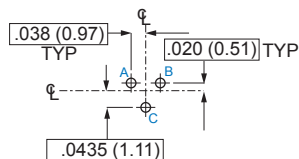

Pin Connector

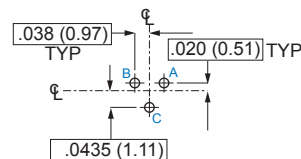

Socket Connector

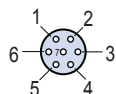

Insert Arrangement

6-7, 8-7

7 #23 Contacts
.022 (0.56) Max. Dia. Tail

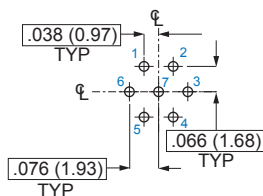

Pin Connector

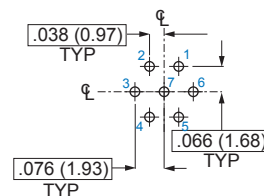

Socket Connector

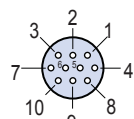

Insert Arrangement

7-10, 9-10

10 #23 Contacts
.022 (0.56) Max. Dia. Tail

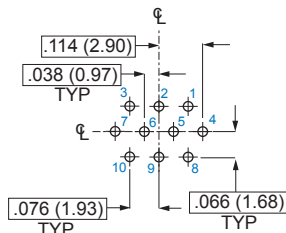

Pin Connector

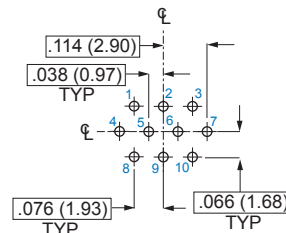

Socket Connector



Insert Arrangement

8-2, 10-2

2 #16 Contacts

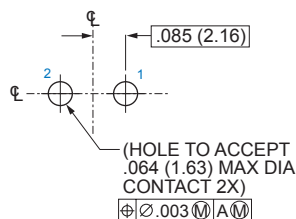

Pin Connector

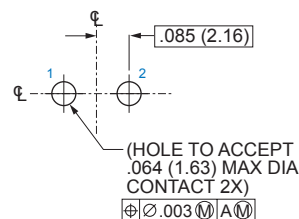

Socket Connector

Dimensions in inches (millimeters) and are subject to change without notice.

Series 80 "Mighty Mouse" Straight PCB Footprints

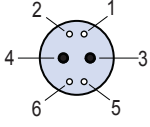
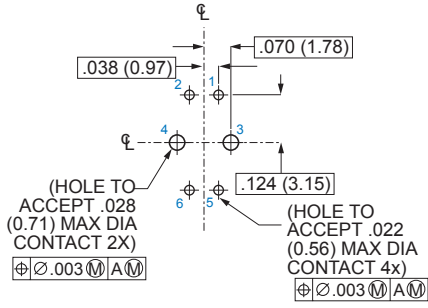
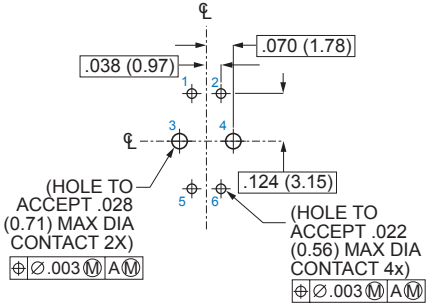
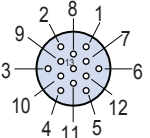
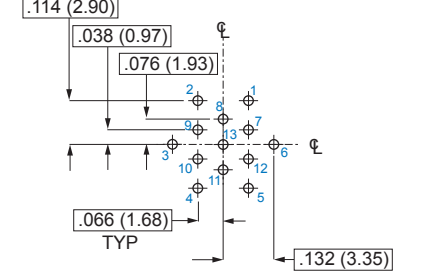
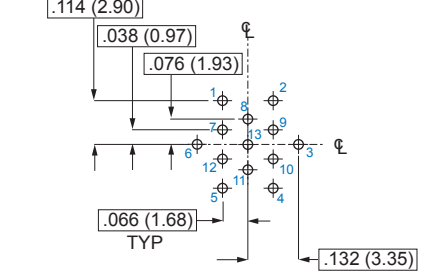
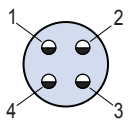
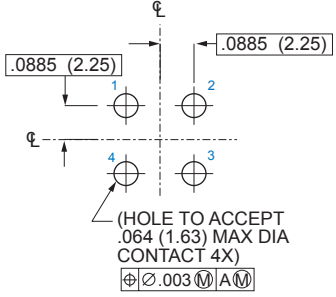
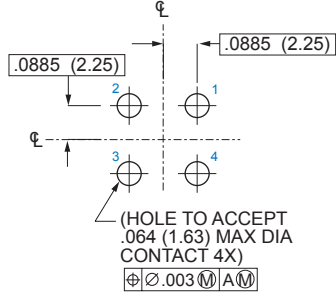
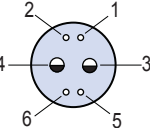
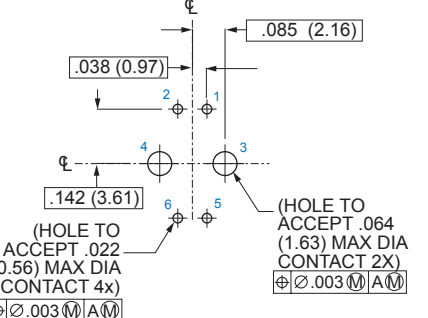
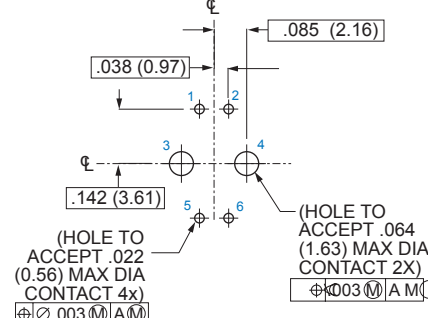

Component Mounting Side of PCB

 <p>Insert Arrangement 8-200, 10-200 2 #20 Contacts 4 #23 Contacts</p>	 <p>Pin Connector</p>	 <p>Socket Connector</p>
 <p>Insert Arrangement 8-13, 10-13 13 #23 Contacts .022 (0.56) Max. Dia. Tail</p>	 <p>Pin Connector</p>	 <p>Socket Connector</p>
 <p>Insert Arrangement 9-4, 11-4 4 #16 Contacts</p>	 <p>Pin Connector</p>	 <p>Socket Connector</p>
 <p>Insert Arrangement 9-200, 11-200 4 #23 Contacts 2 #16 Contacts</p>	 <p>Pin Connector</p>	 <p>Socket Connector</p>

Dimensions in inches (millimeters) and are subject to change without notice.

Component Mounting Side of PCB

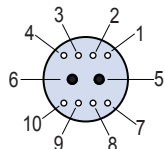

Insert Arrangement
9-201, 11-201
2 #20 Contacts
8 #23 Contacts

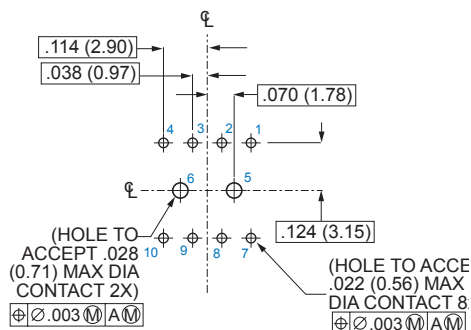

Pin Connector

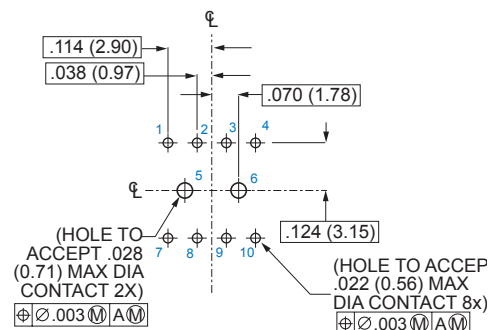

Socket Connector

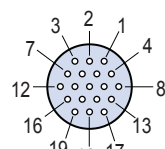

Insert Arrangement
9-19, 11-19
19 #23 Contacts
.022 (0.56) Max. Dia. Tail

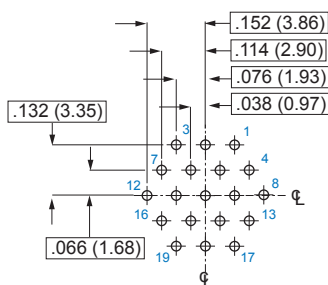

Pin Connector

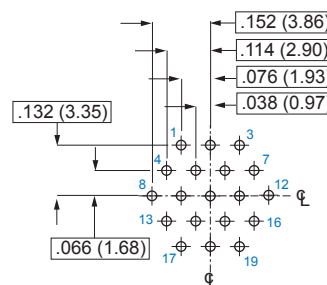

Socket Connector

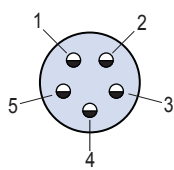

Insert Arrangement
10-5, 12-5
5 #16 Contacts

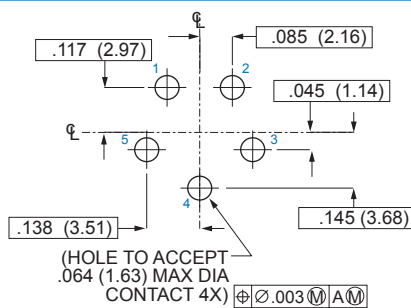

Pin Connector

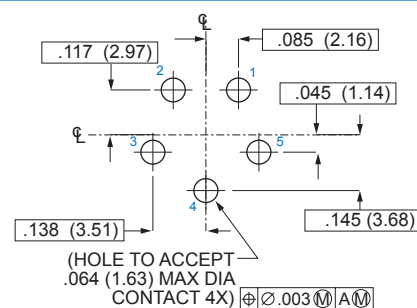

Socket Connector

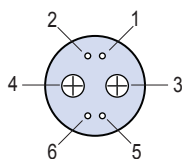

Insert Arrangement
10-201, 12-201
2 #12 Contacts
4 #23 Contacts

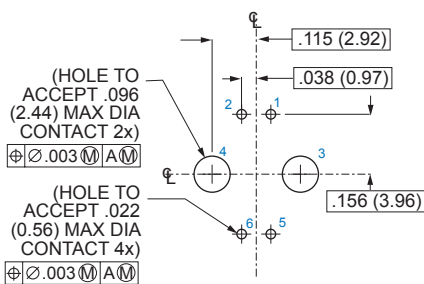

Pin Connector

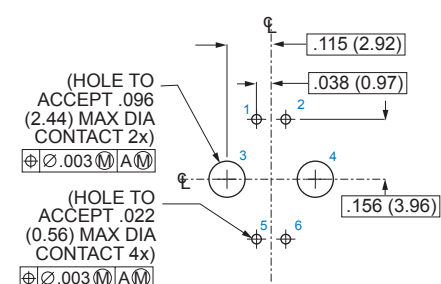

Socket Connector

Dimensions in inches (millimeters) and are subject to change without notice.

Series 80 "Mighty Mouse" Straight PCB Footprints

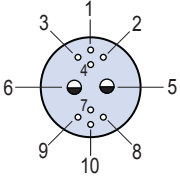
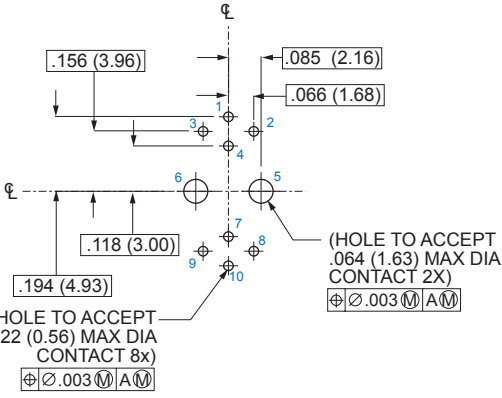
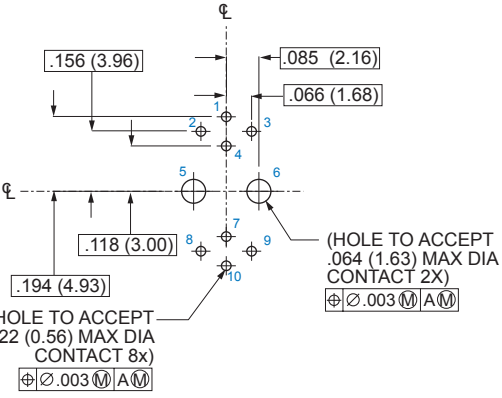
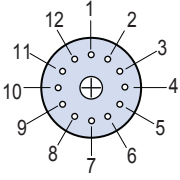
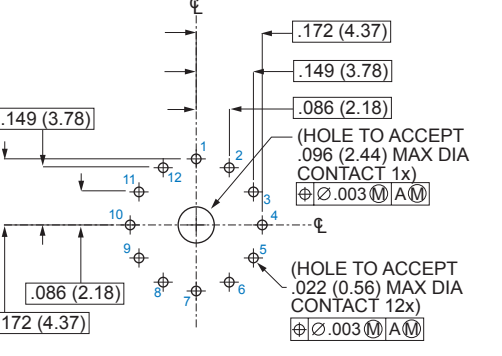
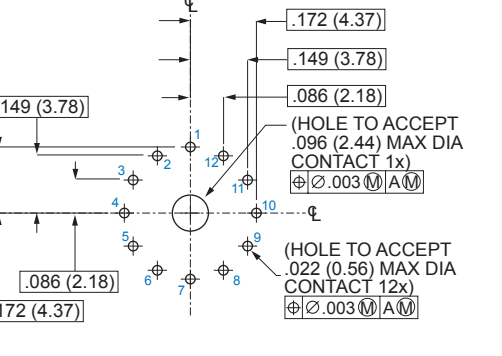
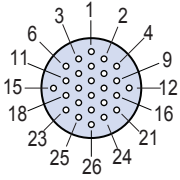
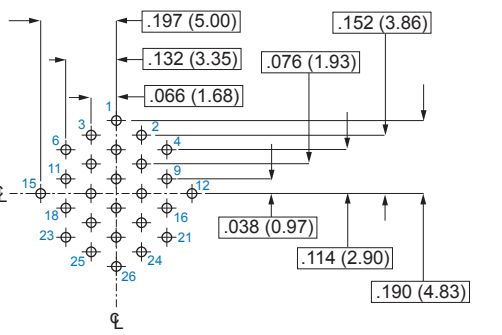
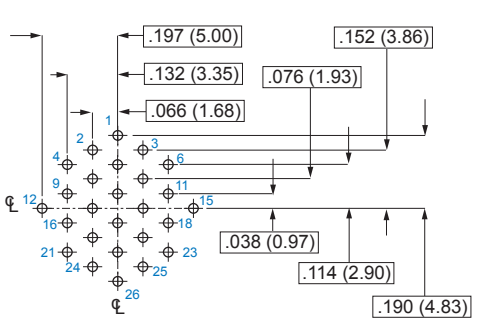

Component Mounting Side of PCB

 <p>Insert Arrangement 10-202, 12-202 2 #16 Contacts 8 #23 Contacts</p>	 <p>Pin Connector</p>	 <p>Socket Connector</p>
 <p>Insert Arrangement 10-200, 12-200 1 #12 Contact 12 #23 Contacts</p>	 <p>Pin Connector</p>	 <p>Socket Connector</p>
 <p>Insert Arrangement 10-26, 12-26 26 #23 Contacts .022 (0.56) Max. Dia. Tail</p>	 <p>Pin Connector</p>	 <p>Socket Connector</p>

Dimensions in inches (millimeters) and are subject to change without notice.

Component Mounting Side of PCB

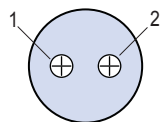

Insert Arrangement
12-2, 13-2, 15-2
2 #12 Contacts

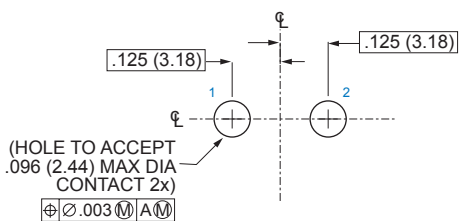

Pin Connector

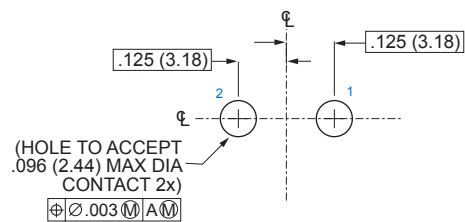

Socket Connector

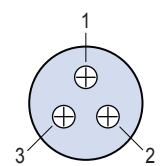

Insert Arrangement
12-3, 13-3, 15-3
3 #12 Contacts

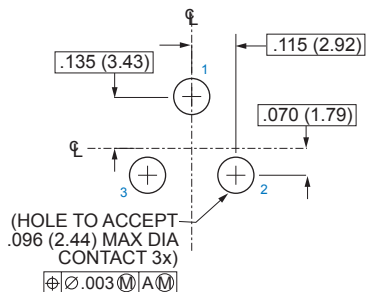

Pin Connector

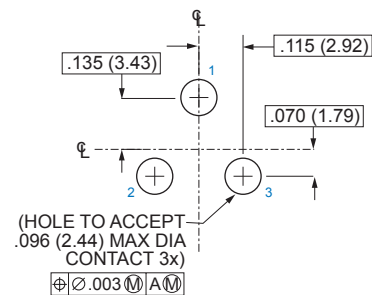

Socket Connector

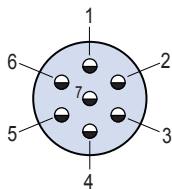

Insert Arrangement
12-7, 13-7, 15-7
7 #16 Contacts

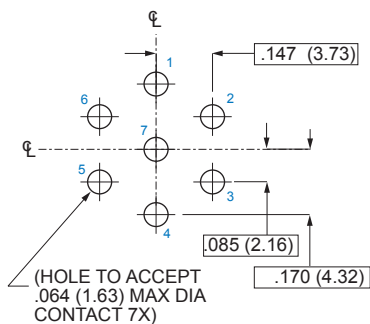

Pin Connector

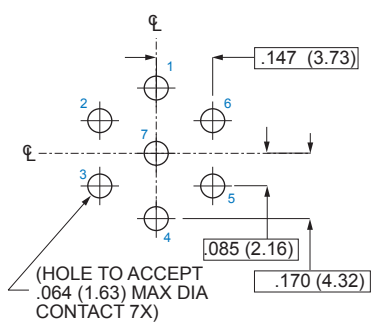

Socket Connector

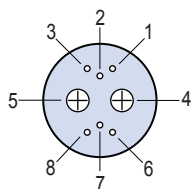

Insert Arrangement
12-200, 13-200, 15-200
2 #12 Contacts
6 #23 Contacts

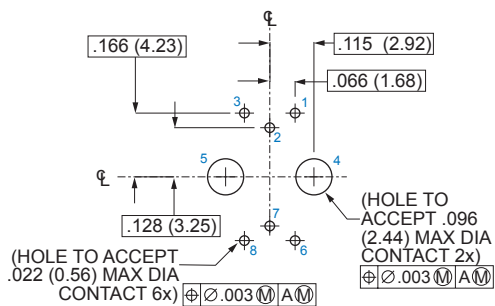

Pin Connector

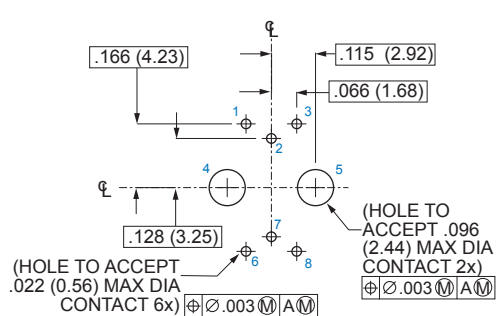

Socket Connector

Dimensions in inches (millimeters) and are subject to change without notice.

Series 80 "Mighty Mouse" Straight PCB Footprints



Component Mounting Side of PCB

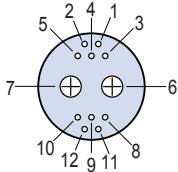

Insert Arrangement
12-201, 13-201, 15-201
2 #12 Contacts
10 #23 Contacts

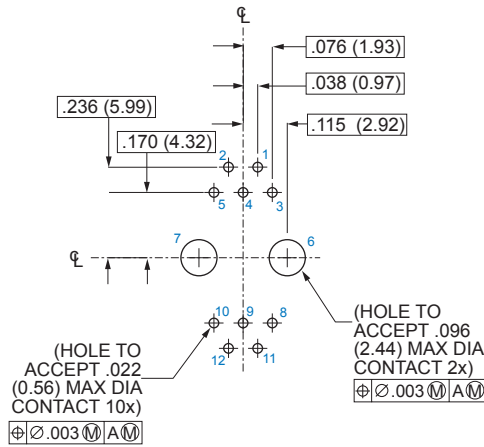

Pin Connector

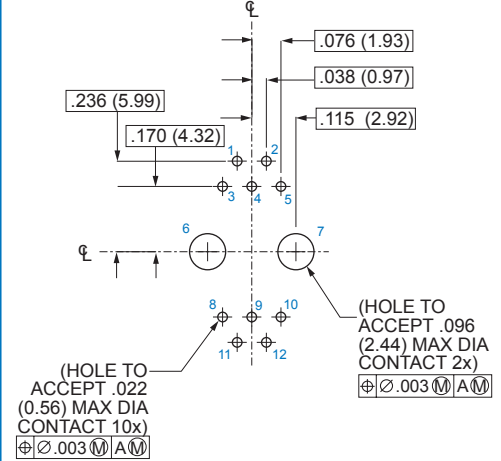

Socket Connector

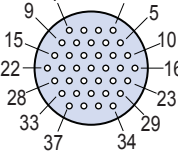

Insert Arrangement
12-37, 13-37, 15-37
37 #23 Contacts
.022 (0.56) Max. Dia. Tail

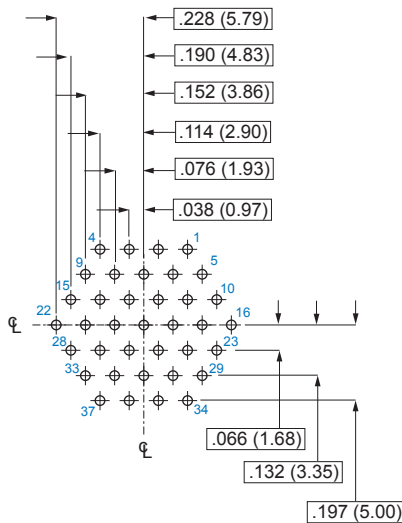

Pin Connector

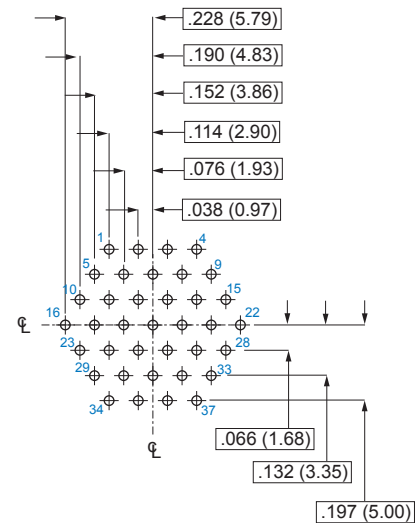

Socket Connector

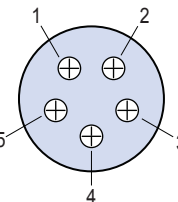

Insert Arrangement
14-5, 16-5, 18-5
5 #12 Contacts

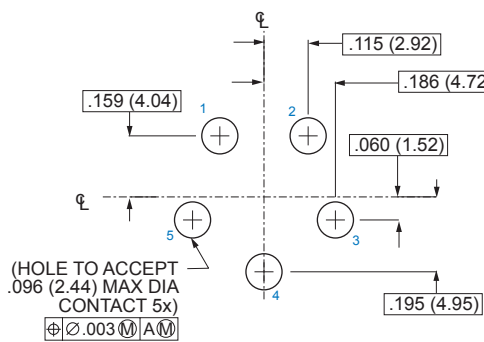

Pin Connector

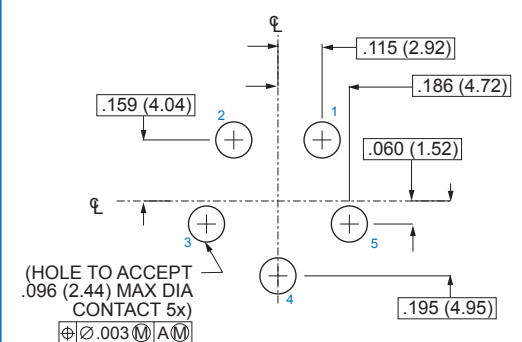

Socket Connector

Dimensions in inches (millimeters) and are subject to change without notice.

Component Mounting Side of PCB

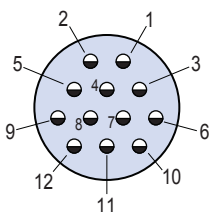

Insert Arrangement
14-12, 16-12, 18-12
12 #16 Contacts

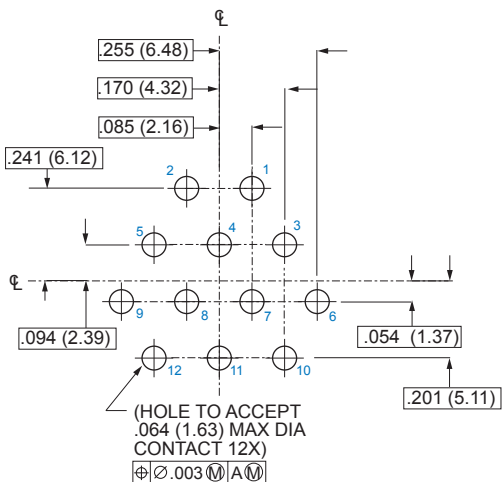

Pin Connector

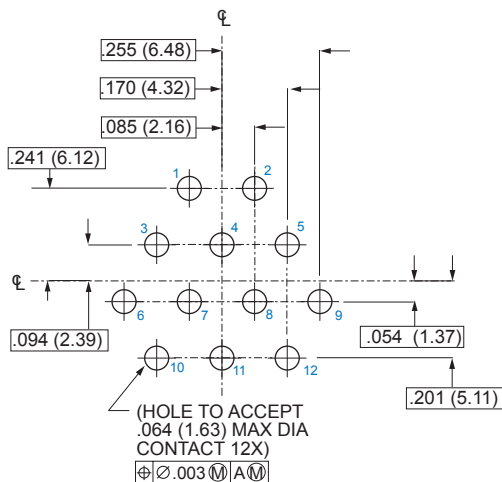

Socket Connector

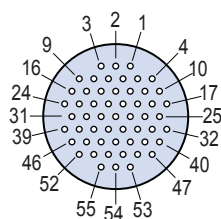

Insert Arrangement
14-55, 16-55, 18-55
55 #23 Contacts
.022 (0.56) Max. Dia. Tail

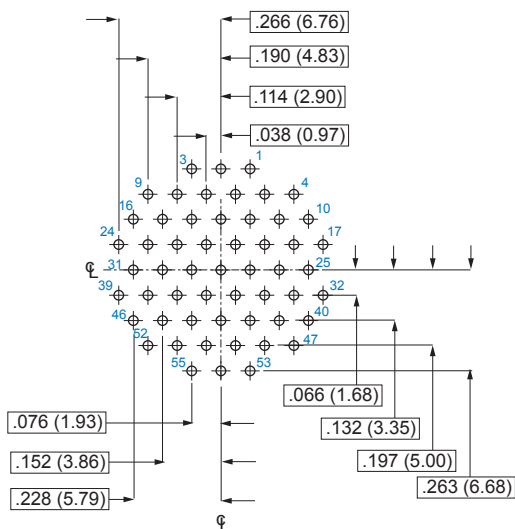

Pin Connector

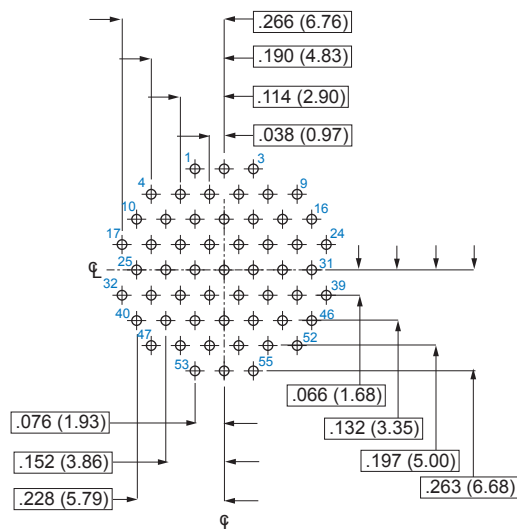

Socket Connector

Dimensions in inches (millimeters) and are subject to change without notice.

Series 80 "Mighty Mouse" Straight PCB Footprints



Component Mounting Side of PCB

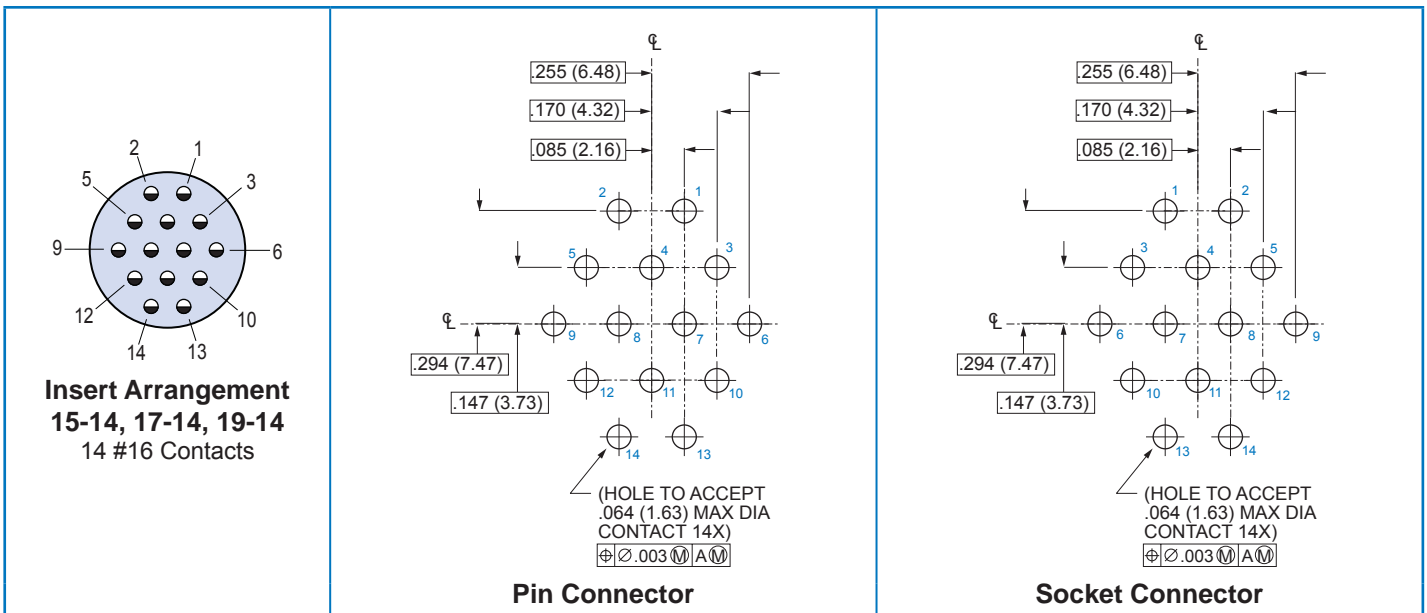
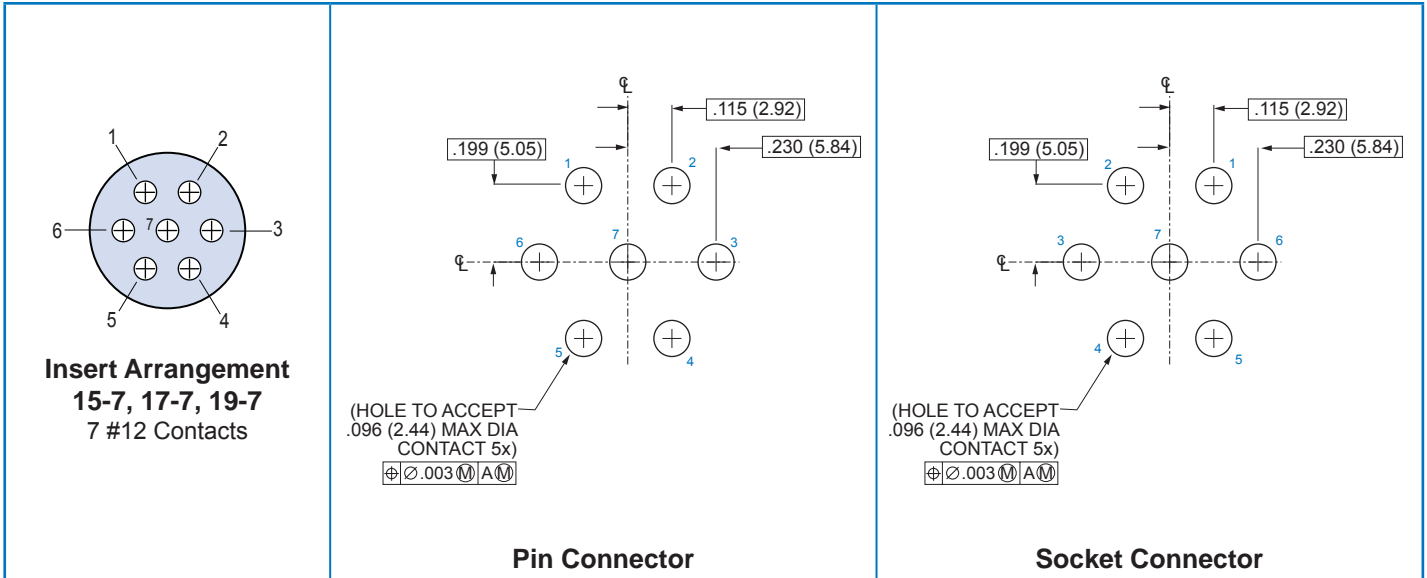

Dimensions in inches (millimeters) and are subject to change without notice.

Component Mounting Side of PCB

B

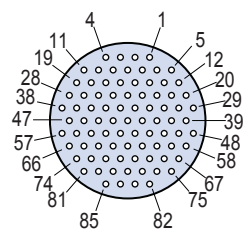

Insert Arrangement

15-85, 17-85, 19-85

85 #23 Contacts

.022 (0.56) Max. Dia. Tail

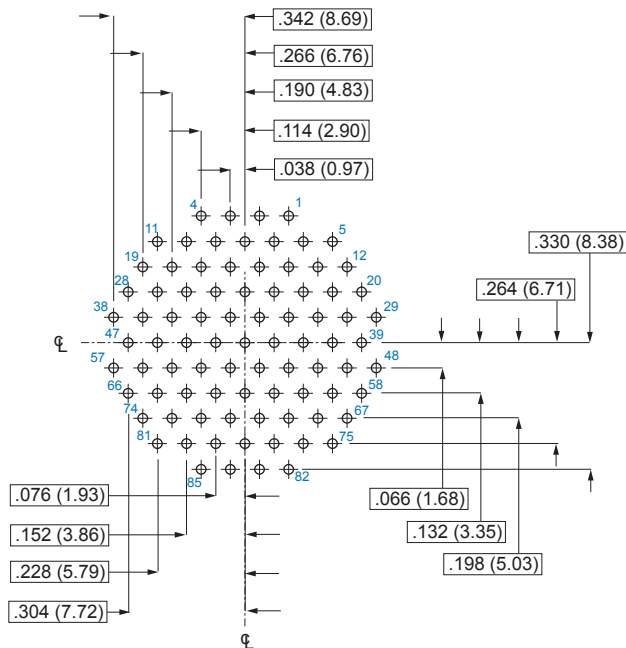

Pin Connector

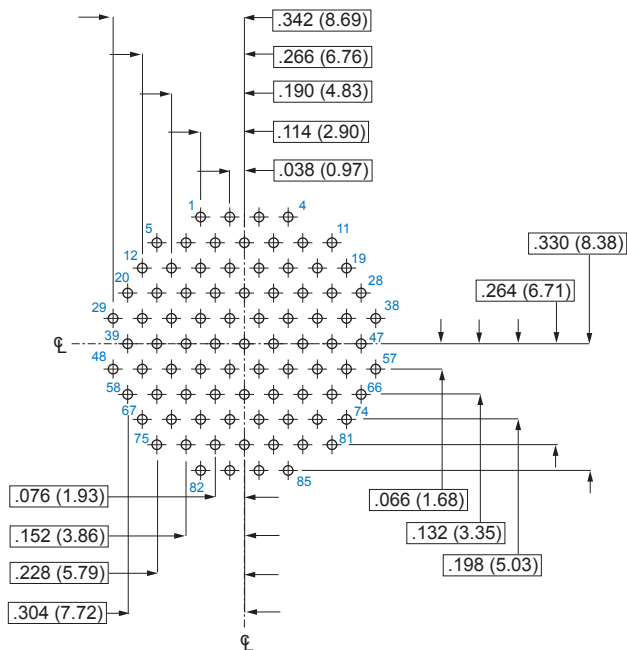

Socket Connector

Dimensions in inches (millimeters) and are subject to change without notice.

© 2009 Glenair, Inc.

CAGE Code 06324

Printed in U.S.A.

GLENAIR, INC. • 1211 AIR WAY • GLENDALE, CA 91201-2497 • 818-247-6000 • FAX 818-500-9912

www.glenair.com

B-12

E-Mail: sales@glenair.com

Rev. 03-FEB-2009

Component Mounting Side of PCB

B

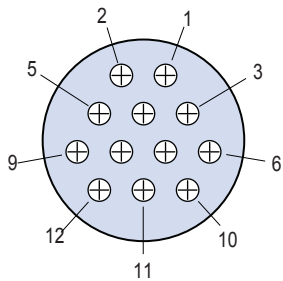

Insert Arrangement
21-12, 23-12
12 #12 Contacts

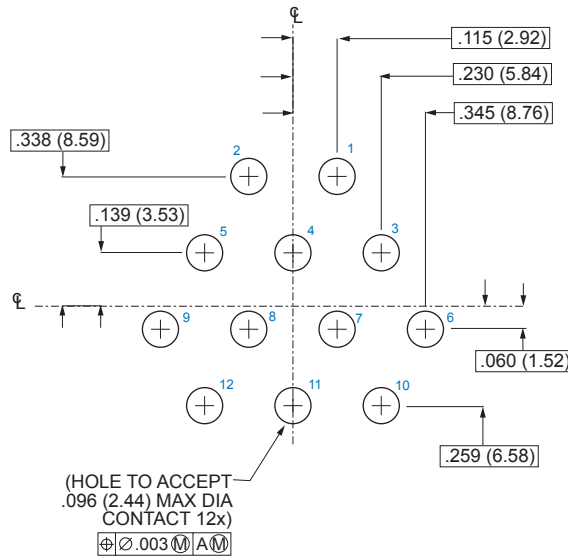

Pin Connector

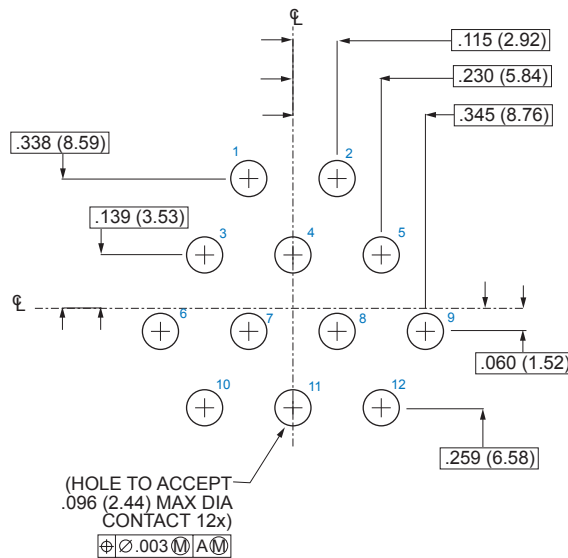

Socket Connector

Dimensions in inches (millimeters) and are subject to change without notice.

Component Mounting Side of PCB

B

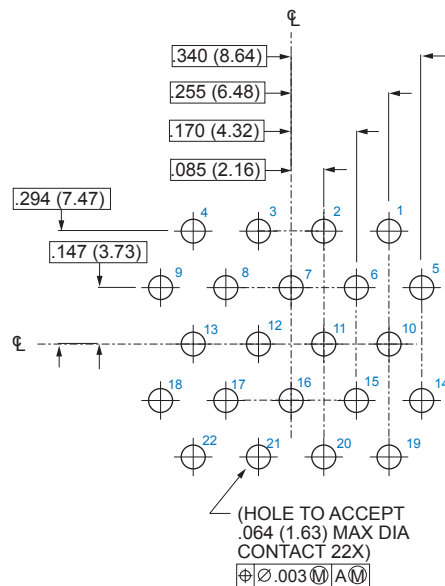

Pin Connector

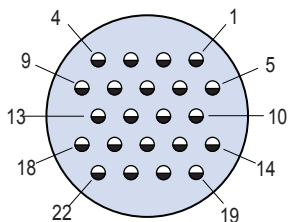

Insert Arrangement
21-22, 23-22
22 #16 Contacts

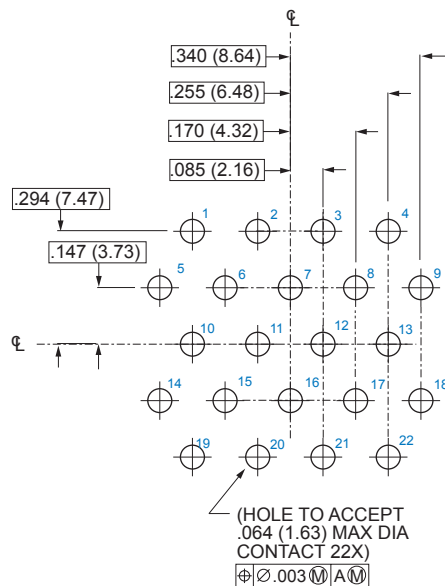

Socket Connector

Dimensions in inches (millimeters) and are subject to change without notice.

© 2009 Glenair, Inc.

CAGE Code 06324

Printed in U.S.A.

GLENAIR, INC. • 1211 AIR WAY • GLENDALE, CA 91201-2497 • 818-247-6000 • FAX 818-500-9912

www.glenair.com

B-14

E-Mail: sales@glenair.com

Rev. 03-FEB-2009

Series 80 "Mighty Mouse" Straight PCB Footprints



Component Mounting Side of PCB

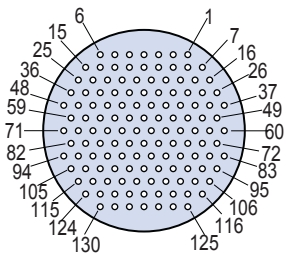

Insert Arrangement

21-130, 23-130

130 #23 Contacts

.022 (0.56) Max. Dia. Tail

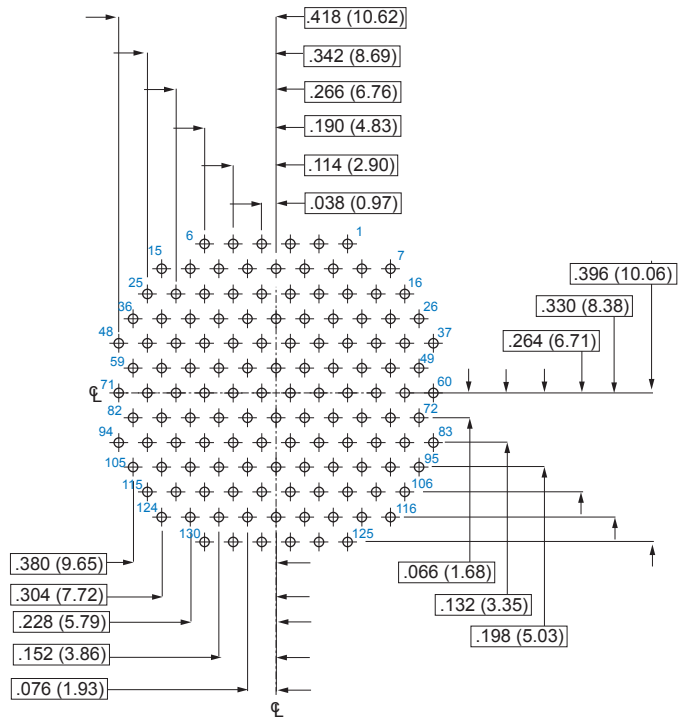

Pin Connector

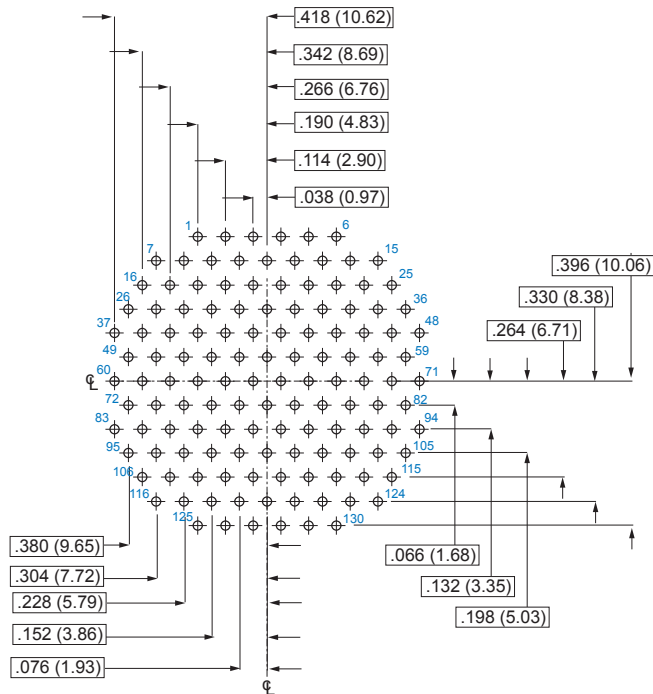

Socket Connector

Dimensions in inches (millimeters) and are subject to change without notice.